

# Sonoclot<sup>®</sup> Coagulation Analyzer Operator's Manual

**REF** SC1 Revision 3.5



Manufactured for: ***Sienco, Inc.***  
5721 Arapahoe Ave, Unit A1-A Boulder, CO 80303 USA  
303-420-1148 1-800-432-1624  
www.sienco.com e-mail: [sienco@sienco.com](mailto:sienco@sienco.com)

Copyright © 1999-2021 Sienco®, Inc. All Rights Reserved.



Manufactured For: Sienco®, Inc.  
5721 Arapahoe Ave, Unit A1-A Boulder, CO 80303 USA  
303/ 420-1148 • [sienco@sienco.com](mailto:sienco@sienco.com) (e-mail)  
<http://www.sienco.com>

Sonoclot® is a registered trademark of Sienco®, Inc.

Sonoclot® Analyzers are protected under U.S. and foreign patents.



QNET BV  
Kantsraat 19  
NL-5076 NP Haaren  
The Netherlands



# Table of Contents

---

## **Chapter 1: Installation and Setup**

Principle of Operation and Intended Use	1-1
Head Assembly	1-1
Model SC1 - Front View	1-2
Model SC1 - Back View	1-2
Package Contents	1-3
Installation	1-3
Good Operating Procedures (applicable for all tests)	1-4
Warnings, Cautions, and Hazards	1-6
Quality Control	1-6

## **Chapter 2: Running a Whole Blood Sample**

Analyzer Preparation	2-1
Cuvette and Probe Setup	2-2
Obtaining the Blood Sample	2-3
Running the Analyzer	2-3

## **Chapter 3: Maintenance and Troubleshooting**

Maintenance	3-1
Troubleshooting	3-2
Warning and Error Messages	3-2
Factory Service or Repair	3-3

## **Appendix**

References	A-1
Warranty	A-2
Technical Specifications	A-2
Environmental Conditions for Transportation and Storage	A-2
Environmental Conditions for Use	A-3
Electrical Classification	A-3
Disposal Instructions	A-3
Glossary of International Symbols	A-4
Decontamination Form	A-5

---



# Chapter 1: Installation and Setup

## Principle of Operation and Intended Use

The Sonoclot® Coagulation Analyzer monitors viscoelastic changes occurring within a blood sample as the sample evolves from a liquid into a mature clot. The blood sample temperature is regulated to 37°C. Each coagulation test begins with a mixing cycle to disperse the test activation reagent throughout the blood sample. The sample's viscoelastic properties are sensed with a tubular probe which is immersed within the sample. The probe oscillates up and down within the sample. As the probe moves within the sample, the blood's viscosity resists this motion. This resistance to motion is converted into a viscosity measurement. As the blood sample changes from the initial liquid state into a clot the viscosity measurement increases. The analyzer automatically calculates two results: the time required to initiate clot formation, referred to as an activated clotting time (ACT) and the rate of clot formation, referred to as Clot Rate (CR). Results are reported on the analyzer LCD display.

The intended use depends on the specific test run on the analyzer. Different tests are formulated with optimized reagents to achieve specific clinical objectives. Tests are available for a variety of clinical objectives including: heparin concentration management, low molecular weight heparin management, hypercoagulation or hypocoagulation screening, and clinical bleeding management.

## Head Assembly

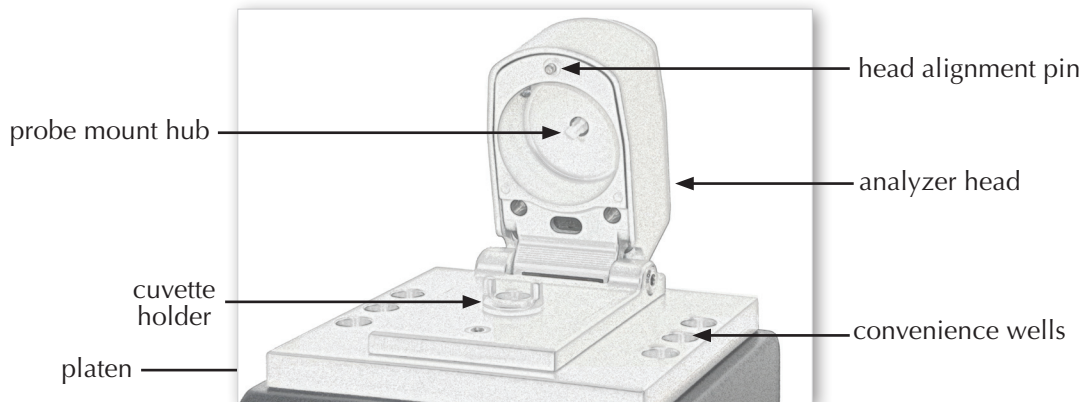

## Model SC1 - Front View

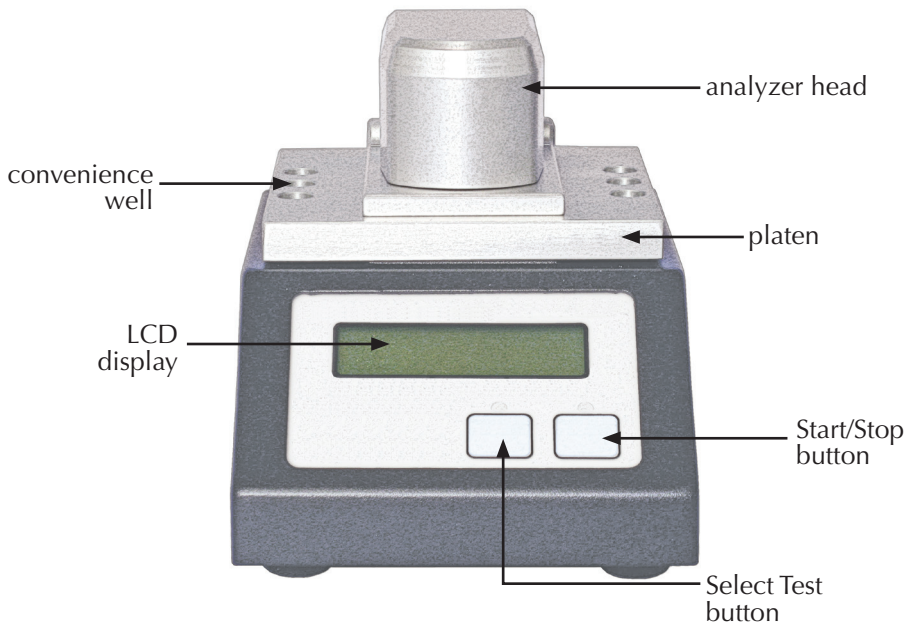

## Model SC1 - Back View

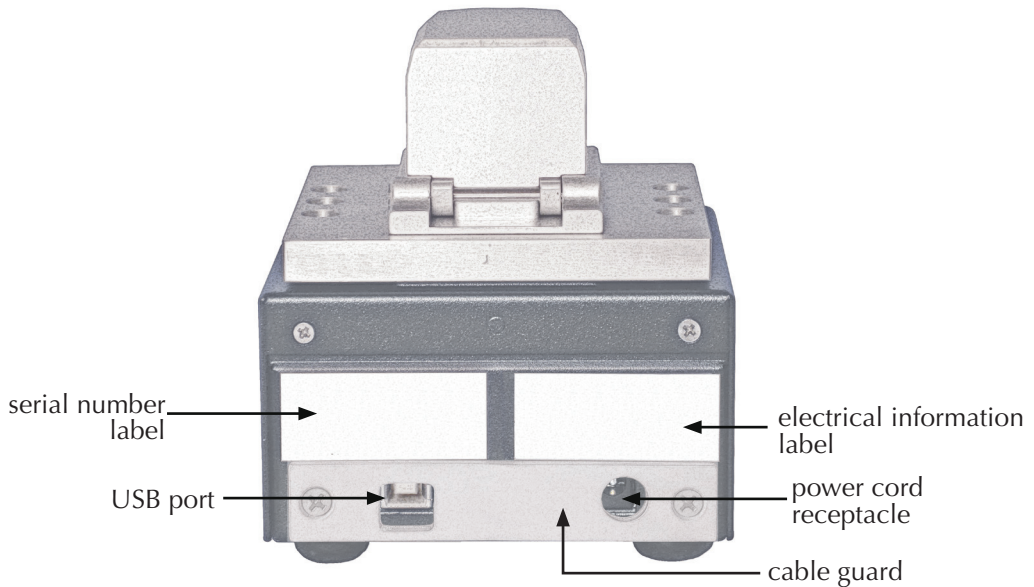

## Package Contents

- Sonoclot® Coagulation Analyzer (Model SC1)
- power adaptor and cord
- probe extractor
- operator's manual
- USB cord
- SonoView installation CD

## Installation

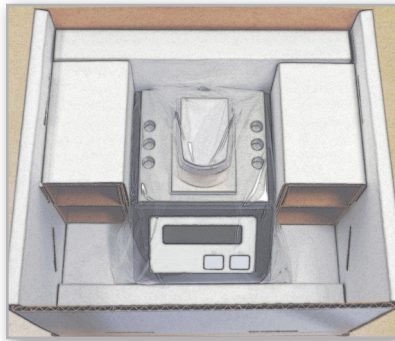

- 1) Remove the accessories and cardboard inserts from the box and check for all of the listed items.

NOTE: Keep the original box and cardboard inserts in case the analyzer needs to be returned for service.

- 2) Remove the analyzer from the box and the plastic bag. Removing all of the cardboard inserts makes it easier to remove the analyzer from the box.
- 3) Plug the power cord into the analyzer and an easily accessible grounded wall outlet. Do not use an ungrounded extension cord or adaptor. Do not obstruct access to the outlet.
- 4) The analyzer will automatically turn on. First, the LCD display will illuminate. Next, the analyzer will display the product name, version number, and copyright.
- 5) The analyzer will begin warming. While warming, the display reads:

gbACT	
Heating	36.3 °

- 6) When the analyzer has reached 37.0°C, the display indicates the default test. The analyzer is now ready to run a test.
- 7) Review the remainder of this chapter.

## Installing & Using SonoView Data Management Software (SonoView)

The analyzer indicates real time results on the LCD display. It also collects and stores data much like a digital camera. This data can be accessed by connecting the analyzer to a computer running SonoView.

To install SonoView on your computer:

- 1) Read the installation instructions and hardware specifications on the CD sleeve. Instructions are also located in PDF format on the CD.
- 2) Plug a USB cord into the back of the analyzer and a USB port on your computer. NOTE: The analyzer requires a 1.1 USB Port or higher.
- 3) Open SonoView on your computer. For software instructions, please see the SonoView operator's manual PDF file on the installation disk.

## Good Operating Procedures (applicable for all tests)

The quality of test results depends on proper technique. Carefully follow these good operating procedures:

- 1) Completely read this manual before operating the analyzer.
- 2) Only properly trained lab personnel and healthcare professionals should operate the analyzer.
- 3) Diagnosis should be based on test results in combination with clinical observations.
- 4) Handle materials with care:
  - When taking a blood sample, avoid heparin contamination from catheters.
  - Never use the first sample from a new line to avoid sample contamination with tissue thromboplastin.
  - Keep blood, dirt, and other substances away from the probe mount hub to avoid contaminating the electromechanical transducer.
  - Never reuse a probe or cuvette to prevent thrombin contamination.
- 5) For consistent results, the cuvettes should be warmed prior to analysis. To warm, place the cuvette in its holder at least 30 seconds prior to running a test.
- 6) Always insert and remove the probe by moving it vertically over the probe mount hub. Never move the hub horizontally. Make sure the probe is fully seated to avoid interference with the stir-bar.
- 7) Always remove the cuvette lid prior to placing it into the cuvette holder. Failure to do so can damage the transducer.



- 8) Do not remove the cuvette lid while the cuvette is in the cuvette holder; the cuvette holder may break. Always place the cuvette in a convenience well to remove the lid.
- 9) The cuvette must be fully seated in the cuvette holder to avoid interference between the probe and stir-bar. When placing the cuvette into the holder, verify that the cuvette contains a stir-bar.
- 10) Do not overfill the cuvette. The proper fill level is 330 to 360  $\mu$ l, slightly below the inner rim of the cuvette.
- 11) Always close the head gently, ensuring the alignment pin is centered in the guide and the head is flat on the platen. Do not drop the head closed to avoid damaging the analyzer.
- 12) After closing the head, verify the clot signal reading changes from 0 to a value typically between 5 and 30 clot signal units. A clot signal reading of 0 indicates there is no probe on the probe mount hub. A high clot signal reading (>200) indicates likely interference between the probe and the stir-bar.
- 13) Native whole blood must be analyzed within 2 minutes or less of collection.
- 14) Perform QC testing to verify proper operation of the analyzer and activation cuvettes. See page 1-6.
- 15) Use proper biohazard handling techniques to dispose of probes and cuvettes.
- 16) Do not move the analyzer when there is probe on the probe mount hub or a cuvette in the cuvette holder. It may damage the analyzer. Always remove the probe and the cuvette before moving the analyzer.
- 17) On rare occasions, mechanical disturbances may cause incorrect results. Always inspect results to ensure that they are consistent.
- 18) Extremely high viscosity blood samples (immersion response on analyzer > 25 clot signal units) can stratify. Use an external device to mix the blood sample before filling the cuvette.

## Warnings, Cautions, and Hazards



**WARNING:** As with any laboratory test result, diagnosis should not be based solely on Sonoclot Analyzer test results. The attending physician is responsible for interpreting the analyzer test results in conjunction with the patient's condition, other test results, and clinical observations.



**WARNING:** To safeguard against electrical shock, only use a grounded electrical outlet.



**WARNING:** Use only as specified by this operator's manual or test instructions for use. Unspecified use may result in damage to the analyzer and will void the warranty.



**CAUTION:** Only properly trained laboratory personnel and health care professionals should operate the analyzer.



**CAUTION:** A biomedical engineering department should check the analyzer at least once a year for compliance with leakage standards.



**HAZARD:** Human blood is a biohazardous material. The operator should wear appropriate protective gear when handling blood and/or test cuvettes containing blood samples. Biocontaminated materials should be handled and disposed of properly in accordance with hospital and governmental regulations.



**CAUTION:** Do not place the analyzer on counter tops where other vibrating instruments, such as centrifuges, are located. Mechanical vibration may cause erratic results.

## Quality Control

Proper performance requires regular quality control (QC) tests:

- 1) Daily, run a reference viscosity test for the analyzer. This requires QC kit 900-1303.
- 2) Monthly, and prior to the use of a new shipment, validate the activated cuvettes. This requires QC kit 900-1318.

Complete instructions and QC result forms are included in the kits.

To order quality control kits, contact Sienco or your distributor.

# Chapter 2:

## Running a Whole Blood Sample

---

This chapter describes how to prepare and run a test with native whole blood samples. Use only test kits available from Sienco, Inc. Sienco offers different tests for different applications and analyzer models. Choose the test best suited for your application and model. Always refer to the test insert for specific test handling requirements.

### Analyzer Preparation

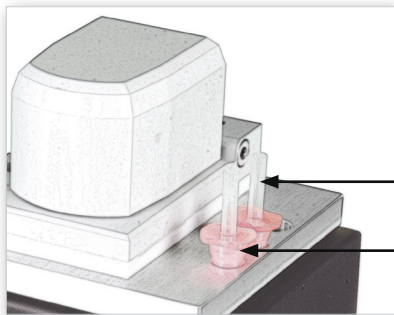

- 1) Place cuvettes in the convenience wells so they will be ready when the blood is drawn. Place probes into the lids of the cuvettes.

- 2) Allow the analyzer to warm, with head assembly in the down position, until it reaches 37°C. The analyzer will not run a test until it has reached operating temperature.

- 3) When the analyzer is ready the display shows the currently selected test:

gbACT

- 4) Press the “Select Test” button on the front panel until the desired test appears on the LCD display.

NOTE: Previous results from the selected test may be shown on the LCD display.

## Cuvette and Probe Setup



- 1) Open the head by tilting it backwards. The display will read "Open."

- 2) Sharply tap the cuvette, cap side up, against a hard surface to dislodge activation powder from the sides and lid.

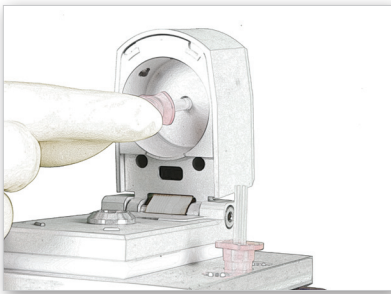

- 3) With a slight twisting motion, use the cuvette to seat the probe on the mount hub. This motion should result in the probe sliding straight over the probe mount hub. **The hub should not move sideways.** The probe must be fully seated for proper operation.



- 4) Remove the cuvette, leaving the probe on the hub.

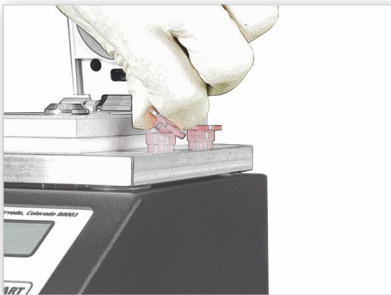

- 5) Place the cuvette in a convenience well and remove the lid by popping it off with your thumb and forefinger. **Do not remove the cuvette lid while the cuvette is in the cuvette holder; the cuvette holder may break.**

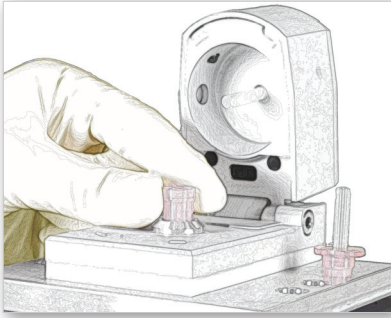

- 6) Insert the opened cuvette into the cuvette holder. Press the cuvette down to make sure it is fully seated. Check that the cuvette contains a stir-bar. Gently close the head. Allow the cuvette to warm in the cuvette holder for at least 30 seconds.

**DO NOT close the head on a lidded cuvette. It will damage the analyzer.**

**DO NOT drop the head closed. It may damage the analyzer.**

Different tests have different set-up requirements. Please refer to the product insert for detailed instructions.

## Obtaining the Blood Sample

Native whole blood must be analyzed within 2 minutes of collection. When drawing blood, observe the following precautions:

- 1) Carefully decide where to draw the sample. Contamination (i.e. from a heparinized line, a heparin-impregnated catheter, or a surgery prep line) will cause inaccurate results.
- 2) Withdraw blood in a smooth, slow, and non-traumatic manner. Do not use force.
- 3) When drawing from an anesthesia or pump port, use a 2-syringe technique. Use the first syringe to draw a sample sufficient to remove any blood that may be affected by the line. Use the second syringe for the sample.
- 4) Human blood is a biohazardous material. The operator should wear appropriate protective gear when handling blood and/or test cuvettes containing blood samples. Biocontaminated materials should be handled and disposed of properly in accordance with hospital and governmental regulations.

## Running the Analyzer



- 1) Transfer the whole blood sample from the syringe into the warmed cuvette. Use a blunt cannula tip for a clean and controlled fill.

Fill the warmed cuvette with the blood sample until the fluid level is slightly below the inner rim of the cuvette. This volume is approximately 330 to 360  $\mu\text{l}$ .

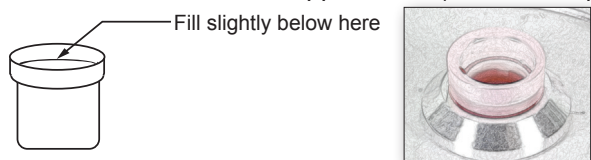

- 2) Leaving the head open, immediately press the START/STOP button.
- 3) The magnetic stirrer will rotate and the display will read "Mixing." Watch the cuvette to make sure the sample is mixing properly.
- 4) When mixing is complete, the analyzer will beep and the display will read "Close Head."

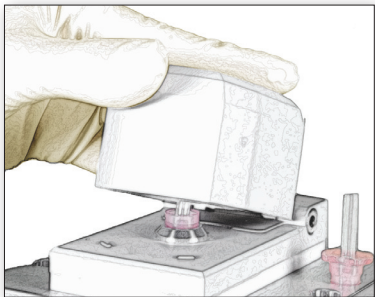

- 5) Gently close the analyzer head. Make sure the alignment pin is centered over the guide and that the head is flat on the platen. **DO NOT drop the head closed. It may damage the analyzer.**

Watch to verify the cot signal reading changes from 0 to approximately 5 to 30 clot signal units.

- 6) During data collection, the LCD display shows the test being run, the clot signal reading (CS), the time in seconds, and "???" for each result. When the analyzer is calculating a result, the display flashes the number the result is greater than.

gbACT	13	11
ACT=????	CR=???	

- 7) The sample is initially a liquid. After several minutes the sample begins to evolve into a clot. The analyzer detects this initial clot formation and calculates the time the sample remained a liquid (ACT). During the next several minutes the fibrinogen begins to transform into a fibrin gel. The analyzer calculates the rate of clot formation (CR).

- 8) When results are calculated, the analyzer beeps and displays the ACT and CR. Times for results vary from 2 to 20 minutes depending on heparin levels and clinical conditions. The numeric result is displayed next to the corresponding text. "NR" is displayed if no results were found for the test sample.

gbACT		
ACT= 177	CR= 19	

- 9) The analyzer automatically stops data collection when all results have been calculated or after the default stop time for the selected test. Test specific stop times are listed in the test instructions for use.



- 10) Open the head and remove the probe from the hub with a probe extractor. Avoid moving the hub sideways. Properly discard the probe and the cuvette. Gently close the head.

# Chapter 3:

## Maintenance and Troubleshooting

---

### Maintenance

#### Cleaning

Clean after use to reduce biohazard risks. The analyzer must also be cleaned prior to returning it for repair.

The analyzer can be sprayed or wiped with a disinfectant approved by your institution. Use caution while cleaning as the transducer attached to the probe mount hub can easily be damaged by debris or liquids. Follow these guidelines when cleaning or disinfecting the analyzer:

- Remove used cuvettes and probes before cleaning the analyzer.
- Gently close the head when spraying to avoid contaminating the transducer.
- Avoid excess wetting.
- Place a clean probe on the probe mount hub to protect the transducer while cleaning.
- Gently wipe around the cuvette holder or inside the head. Do not clean the probe mount hub, unless absolutely necessary.
- Do not use isopropyl alcohol or other solvents on the front panel or LCD display.

#### Calibration & Service

The user can verify proper analyzer performance by running a reference viscosity QC test (900-1303). Sienco recommends performing the reference viscosity QC test daily, prior to use of the analyzer.

Further calibration or service must be performed at the factory. Contact Sienco, Inc. or your distributor to arrange factory service.

## Troubleshooting

If you have a problem with the analyzer, follow these steps:

- 1) Review “Warnings, Cautions, and Hazards” on page 1-6.
- 2) Review “Good Operating Procedures” on page 1-4.
- 3) Review the operating instructions that come with the test you are running.
- 4) If problems persist, contact Sienco or your distributor.

Mail: Sienco Service Department  
5721 Arapahoe Ave, Unit A1-A  
Boulder, CO 80303 USA  
Phone: 303-420-1148  
Toll Free: 800-432-1624  
E-mail: support@sienco.com

## Warning and Error Messages

The Sonoclot Analyzer occasionally displays messages that may not be familiar. Below are some examples of these messages and procedures to follow, if necessary.

“NOISE” indicates that the clot signal is being disturbed by either mechanical noise, such as bumping the analyzer, or by interference between the probe and the cuvette. Check to ensure that the probe is tight against the mount hub and the cuvette is in contact with the bottom of the cuvette holder. The message should disappear within a few seconds.

“ERROR” indicates that the analyzer has detected a problem. Normally, the message will disappear after several seconds. You can resume testing then. If the error message remains, make a note of the error number and contact Sienco or your distributor.

“TEST NOT RUN, NOT AT TEMP” indicates that the analyzer is not to temperature and the test was not run. The analyzer must be at 37°C to run a test.

“NR” indicates that no results were found for the last test analysis. This can occur due to operator error (i.e. failure to close analyzer head within 60 seconds of “Close Head” message), analyzer error, or an unusual clot that cannot be analyzed.

**NUMBERED ERROR CODES:** The analyzer is programmed to display various numbered error codes. Should your analyzer display a numbered error code, record the number displayed and contact Sienco or your distributor.

If you have any questions regarding a display message, contact Sienco or your distributor.



## Factory Service or Repair

Contact Sienco or your distributor prior to shipping your analyzer for repairs.

If possible, ship the analyzer in its original packing materials. If you do not have the original packing materials please contact Sienco or your distributor. Packing materials will be sent or you may use the packing materials from your service loaner.

Damages caused by poor return packaging are your responsibility.

To ship, follow these steps:

- 1) Remove any cuvettes and probes from inside the analyzer. Failure to do so may cause damage during shipping.
- 2) Remove the power cord, USB cord, and any other supplies. These do not need to be included with the analyzer unless requested by Sienco.
- 3) Photocopy the decontamination form at the end of this manual.
- 4) Clean and decontaminate the analyzer according to your institutional guidelines and fill out the decontamination form. Failure to fill out form and include with the analyzer will result in a decontamination fee.
- 5) Place the analyzer in a large, clean plastic bag and fold the open end under the analyzer.
- 6) Make sure the bottom insert is fully seated in the bottom of the box with the cutouts facing up. Place the analyzer in the bottom of the box with the feet aligned in the cutouts.

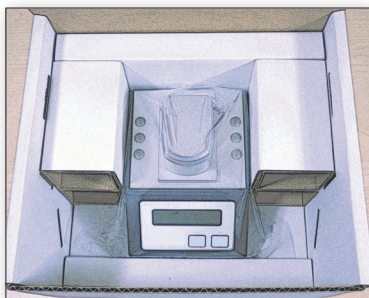

- 7) Place the back insert behind the analyzer so the cutout is on the bottom and facing the analyzer.

Place the side inserts on either side of the analyzer so they are up against the back insert.

Place the front insert between the analyzer and the front of the box.



- 8) Place the cover insert over the analyzer, making sure to align the tabs into the slots in the front and sides of the box.

- 9) If you are also returning your power adaptor and cord, place them in the space in the front of the box.
- 10) Make sure the decontamination form is complete. Be sure to include a brief description of the problem along with a contact name, phone number, and purchase order.
- 11) Place the completed form on top of the cover insert.

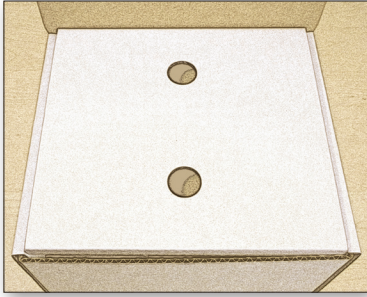

- 12) Place the top insert in the top of the box and close the box.

- 13) Tape the box shut and contact Sienco or your distributor for shipping instructions.

## References

Sonoclot Analysis is used in many clinical and research applications and consequently is referenced in numerous studies and articles. For a complete list of references, please visit [www.sienco.com](http://www.sienco.com).

- 1) Hett DA, Walker D, Pilkington SN, Smith DC. Sonoclot Analysis. *Br J Anaesth*. 1995; 75(6): 771-6.
- 2) Ganter MT, Hofer CK. Coagulation monitoring: current techniques and clinical use of viscoelastic point-of-care coagulation devices. *Anesth Analg*. 2008 May; 106(5):1366-75.
- 3) Liszka-Hackzell JJ, Ekback G. Analysis of the information content in Sonoclot data and reconstruction of coagulation test variables. *Journal of Medical Systems*. 2002; 26(1): 1-8.
- 4) Ekback G, Carlsson O, Schött U. Sonoclot coagulation analysis: a study of test variability. *J Cardiothorac Vasc Anesth*. 1999; 13(4): 393-7.
- 5) Bischof DB, Ganter MT, Shore-Lesserson L et al. Viscoelastic blood coagulation measurement with Sonoclot predicts postoperative bleeding in cardiac surgery after heparin reversal. *J Cardiothorac Vasc Anesth*. 2015 Jan; 29(3):715-722.
- 6) Yamada T, Katori N, Tanaka KA, Takeda J. Impact of Sonoclot hemostasis analysis after cardiopulmonary bypass on postoperative hemorrhage in cardiac surgery. *J Anesth*. 2007; 21(2):148-52.
- 7) Ganter MT, Monn A, Tavakoli R, Klaghofer R, Zollinger A, Hofer CK. Kaolin-based activated coagulation time measured by Sonoclot in patients undergoing cardiopulmonary bypass. *J Cardiothorac Vasc Anesth*. 2007; 21(4):524-8.
- 8) Shibata T, Sasaki Y, Hattori K, et al. Sonoclot analysis in cardiac surgery in dialysis dependent patients. *Ann Thorac Surg*. 2004; 77(1): 220-05.
- 9) Babski DM, Brainard BM, Ralph AG, Pittman JR, Koenig A. Sonoclot evaluation of single- and multiple-dose subcutaneous unfractionated heparin therapy in healthy adult dogs. *J Vet Intern Med*. 2012; 26(3):631-8.
- 10) Tanaka KA, Szlam F, Sun HY, Taketomi T, Levy JH. Thrombin generation assay and viscoelastic coagulation monitors demonstrate differences in the mode of thrombin inhibition between unfractionated heparin and bivalirudin. *Anesth Analg*. 2007; 105(4):933-9.
- 11) Schött U, Nilsson LG, Broman M, Engström M. Monitoring of low molecular weight heparin anticoagulation during haemodialysis with a Sonoclot Analyzer. *Perfusion*. 2010; 25(4):191-6.
- 12) Nilsson CU, Engström M. Monitoring fondaparinux with the Sonoclot. *Blood Coagulation and Fibrinolysis*. 2007; 18: 619-622.

## Warranty

The Sonoclot® Analyzer has a 2 year warranty that it conforms to specifications and is free of defects in material and workmanship. The warranty is limited to the replacement or repair of defective parts and components. The warranty shall be voided if the product is:

- 1) Used in any manner or subjected to any condition that is inconsistent with its intended purpose or accepted industry practice; or
- 2) Modified in any way without prior written approval by Sienco; or
- 3) Repaired in any manner so as to adversely affect its operation or reliability by persons other than Sienco or its agents.

Warranty claims shall be submitted in writing to Sienco during the 2 year warranty period. The claim shall state the nature and details of the analyzer defect and the serial number of the analyzer. The claim must accompany any defective product submitted for repair or replacement.

Purchasers must decontaminate and package the analyzer per instructions on pages 3-1 and 3-3 to avoid damage during shipping. Such products shall, at Sienco's election, be either repaired, replaced or returned.

## Technical Specifications

Width	4.25"	10.8 cm
Depth	5.75"	14.6 cm
Height	4.75"	12.1 cm
Weight	2.5 lbs	1.13 kg
Electrical voltage requirement	100 to 240V	
Electrical power requirement	9V $\overline{=}$ , 2A	
Frequency	50 to 60 Hz	
Temperature regulation of platen	37°C $\pm$ 0.5°C	
Viscosity range for test sample	<300 cP	

## Environmental Conditions for Transportation and Storage



Transport and store within the ambient temperature range of -25°C and 70°C.



Transport and store to a maximum relative ambient humidity of 95%.

## Environmental Conditions for Use

Indoor use only.

Use at a maximum altitude of 2000m.



Use within the ambient temperature range of 18°C and 27°C.

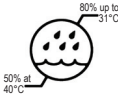

Use at a maximum relative humidity of 80% for temperatures up to 31°C decreasing linearly to 50% relative humidity at 40°C.

Mains supply voltage fluctuation shall not exceed  $\pm 10\%$ .

The unit is intended for INSTALLATION CATEGORY II.

*Installation Category II: Local level, appliances, Portable equipment etc., with smaller transient overvoltages than Installation Category III.*

The unit is intended for use in a POLLUTION DEGREE 2 ENVIRONMENT.

*Pollution Degree 2 is nonconductive pollution of the sort where occasionally a temporary conductivity caused by condensation must be expected. This is the usual pollution degree used for equipment being evaluated to IEC 60950 and is suitable for equipment employed in an office environment.*

## Electrical Classification

This equipment has been tested and found to comply with the limits for a Class A digital device, pursuant to part 15 of the US FCC Rules. These limits are designed to provide reasonable protection against harmful interference when the equipment is operated in its installation. This equipment generates, uses and can radiate radio frequency energy and, if not installed and used in accordance with the instruction manual, may cause harmful interference to radio communications. If this equipment does cause harmful interference the user will be required to correct the interference.

## Disposal Instructions



Sienco, Inc. expects end-users to dispose of the Sonoclot Analyzer in an environmentally friendly way. Electrical and electronic equipment is labeled with the following 'crossed out wheeled bin' symbol indicating that the equipment should be disposed of, by the end-user, separate from other types of waste.



















End-users should contact their dealer/distributor or Sienco, Inc. for disposal, collection and recycling options and terms and conditions in your country.

In 2002 the European Union introduced the Directive on Waste Electrical and Electronic Equipment (WEEE). The main aim of the Directive is to ensure that WEEE is collected and

treated separately. WEEE may contain hazardous substances that should not end-up in the (human) environment and can have adverse effects on it if they do.

WEEE is a vast source of raw materials. With the ever rising worldwide demand for new equipment and the ever decreasing volume of natural raw materials, letting this potential source go to waste is unacceptable. If equipment is collected separately, the equipment can be recycled and up to 85 to 90% of the equipment can be re-used as new material, saving the use of virgin raw materials and energy of producing these.

## Glossary of International Symbols

	Manufacturer		Do not reuse
	In Vitro Diagnostic medical device		Model Number
	Authorized representative in the European community		Lot Number
	CE marking of conformity		Manufacture date
	Biological risk		Expiration date
	Temperature limitation		Consult instructions for use
	Humidity limitation		Contains sufficient for <n> tests
	Direct current (DC)		Caution, consult accompanying documents
	Serial number		Control
	Do not dispose of electrical equipment as municipal waste		

## Decontamination Form

**This decontamination form must be filled out and returned with the Sonoclot Analyzer when returning the analyzer for any reason, or a biohazard decontamination charge will be assessed.**

**Please photocopy this page, complete, and include with your analyzer.**

We require you to thoroughly clean and decontaminate the analyzer per guidelines followed by your institution. Here are some tips to follow when decontaminating the analyzer:

- Place a clean probe on the probe mount hub to protect the transducer while cleaning. Do not spray any cleaning solvent into the head since fluid will damage the transducer.
- Decontaminate all surfaces of the analyzer using a product certified by your institution.
- Remove and discard all probes and cuvettes before packing the analyzer.

Institution: \_\_\_\_\_ Dept: \_\_\_\_\_

Serial Number: \_\_\_\_\_ Model: \_\_\_\_\_

Decontaminated by: \_\_\_\_\_ Date: \_\_\_\_\_

Disinfectant Used: \_\_\_\_\_

Probe removed  Cuvette removed  Power cord & adaptor returned? Y  N

Contact Person: \_\_\_\_\_ Phone: \_\_\_\_\_

Reason for Service: \_\_\_\_\_  
\_\_\_\_\_  
\_\_\_\_\_

An estimated cost for repairs will be provided before any work is done. Please make sure to include a contact name and phone number and/or email address.

Contact Sienco or your distributor for shipping instructions.





